

# 使用輪子來移動

#1

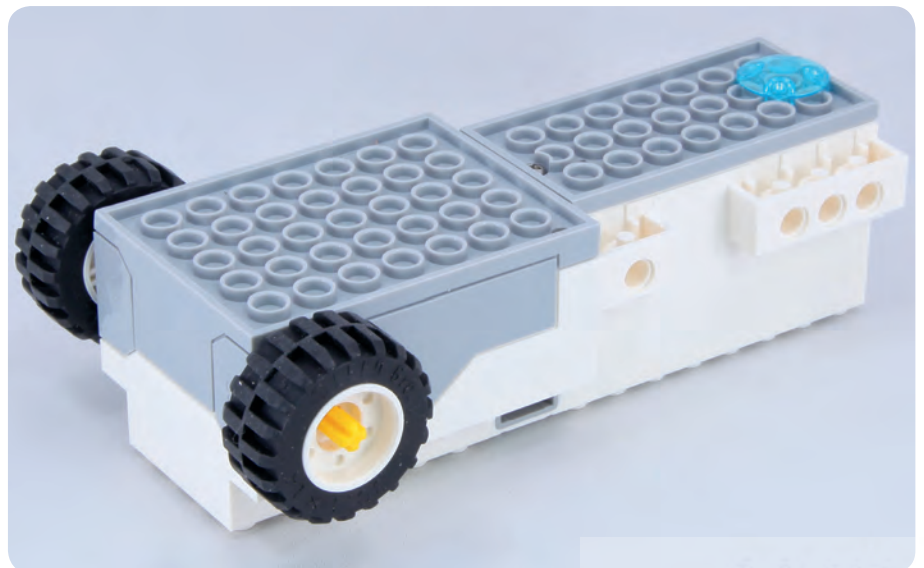

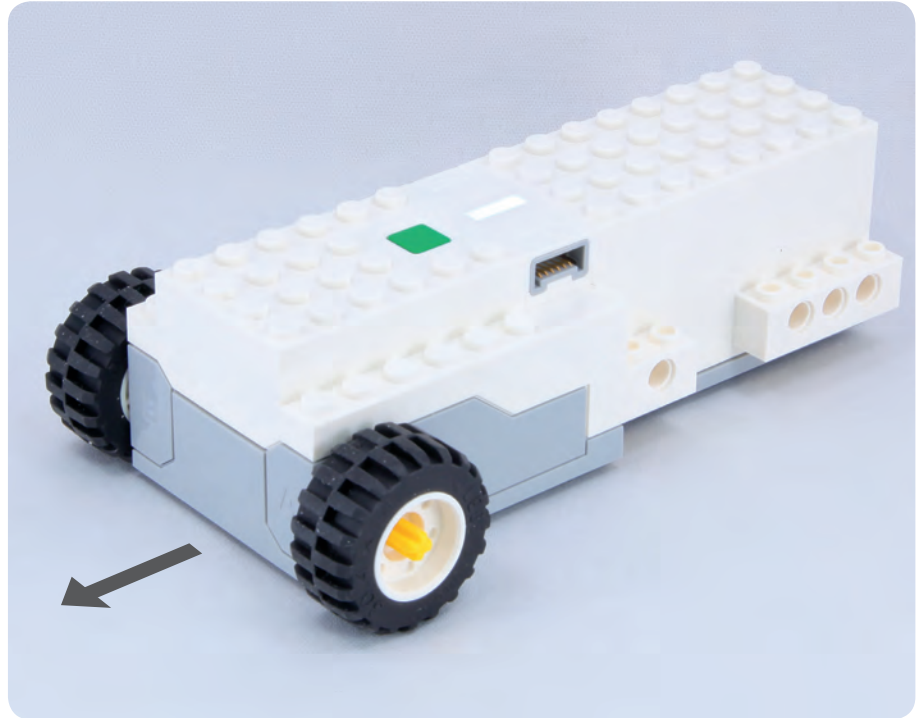
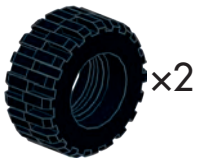
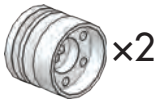
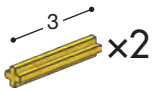
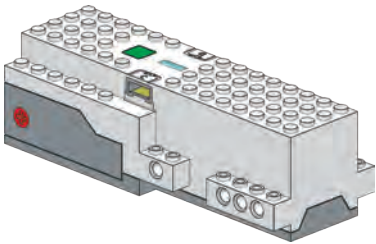
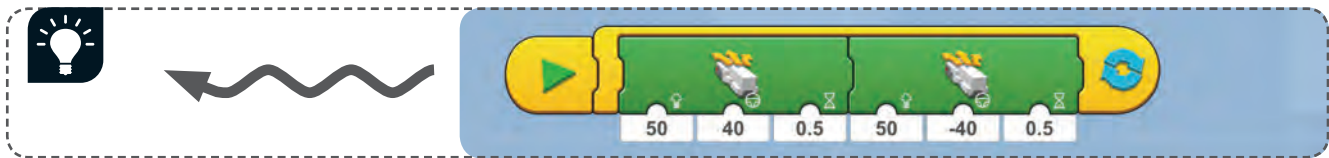
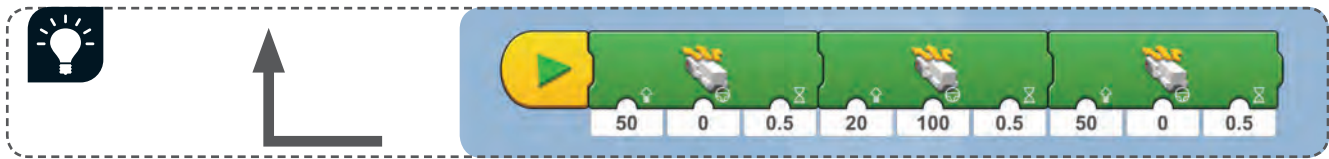

這個搖桿程式中有一個等候 (Wait) 指令，會在程式中產生一小段延遲。如果沒有這個延遲的話，程式會因為裝置不斷送出指令給機器人而搞混—太快而來不及反應啦！

搖桿元件  
請用這個搖桿來控制您的小車。



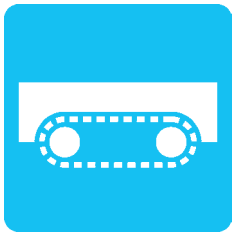

# 使用履帶來移動

#7

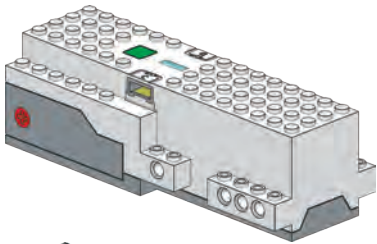

4 x

4 x

4 x

2 x

2 x

2 x

4  
2 x

4  
2 x

38 x

2 x

38 x

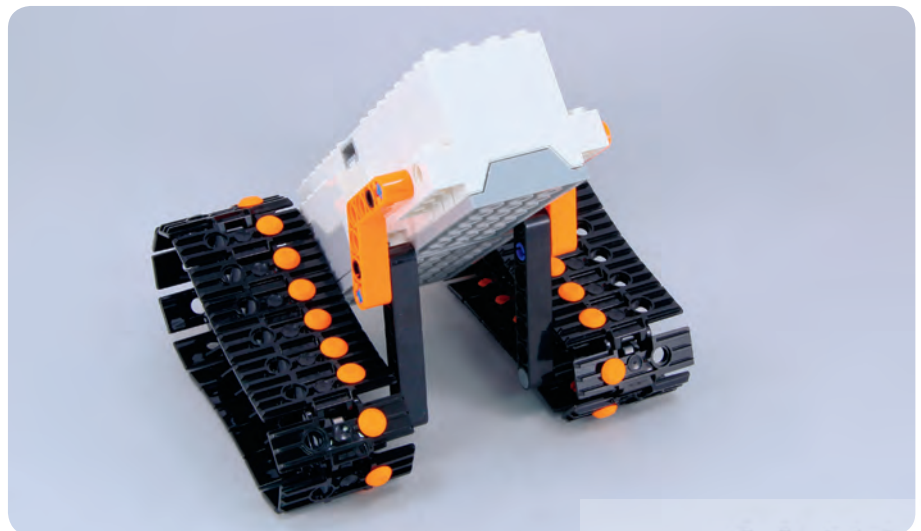
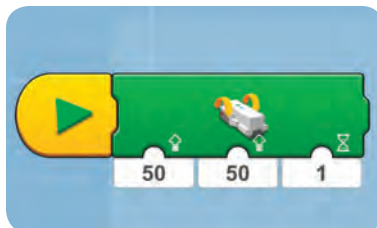

# #8

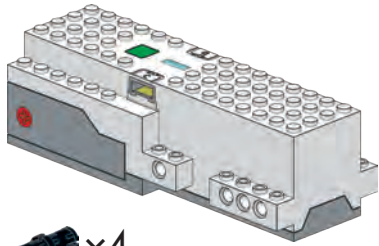

Black axle pin x4

Black axle pin x2

Red axle pin x2

Grey gear x2

Grey gear x2

White axle pin x4

Orange axle pin x38

Grey axle pin x2

Orange axle pin x2

Grey axle pin x2

Blue axle pin x2

Yellow axle pin 3 x2

Brown axle pin 5 x2

Grey axle pin 5.5 x2

Black wheel x2

Black axle pin x38

Black axle pin x2

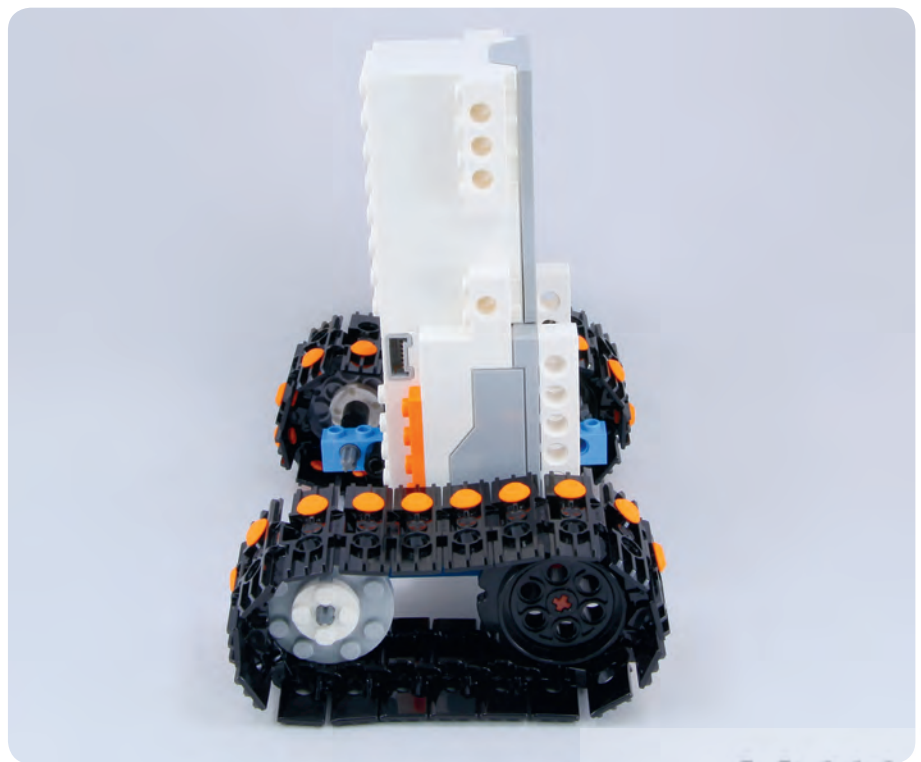
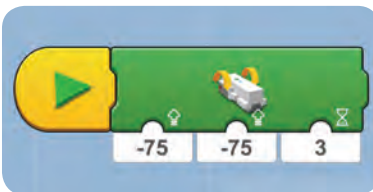

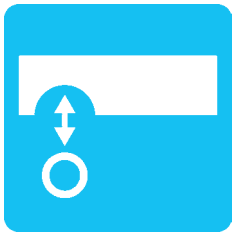

# 有避震器的車子

#9

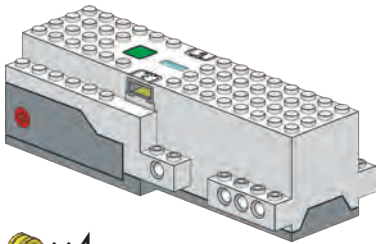

黃圓珠 x4

黑螺絲 x2

黑螺絲 x2

灰齒輪 x2

灰齒輪 x2

紅積木 x1

白圈 x2

白圈 x2

黃長軸 x2

紅長軸 x2

灰L型積木 x2

灰積木 x2

藍積木 x1

灰圓盤 x2

黑輪胎 x2

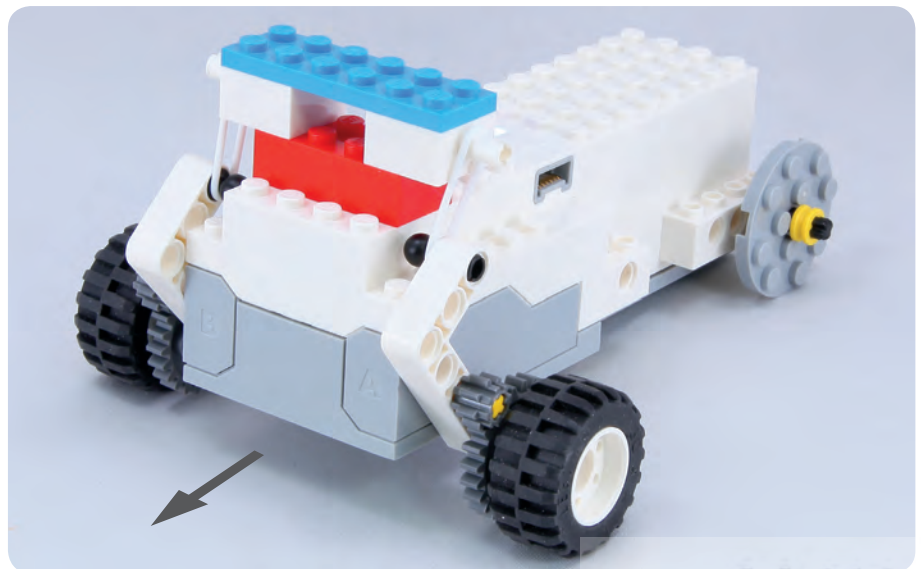
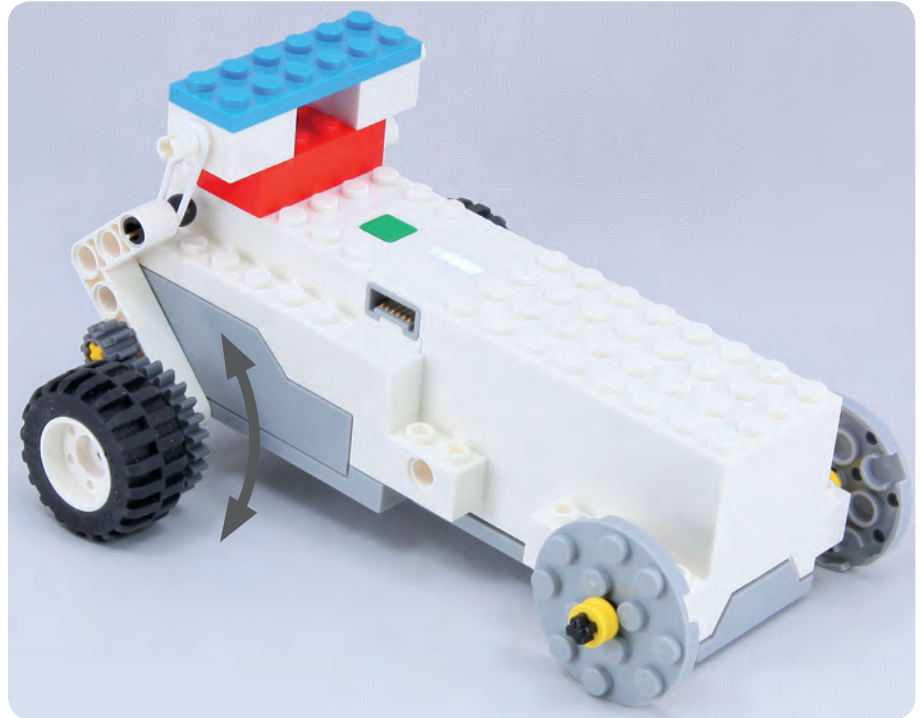

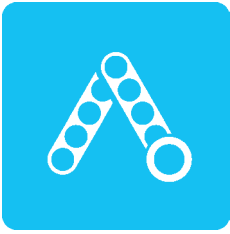

# 像尺蠖一樣移動

# 13

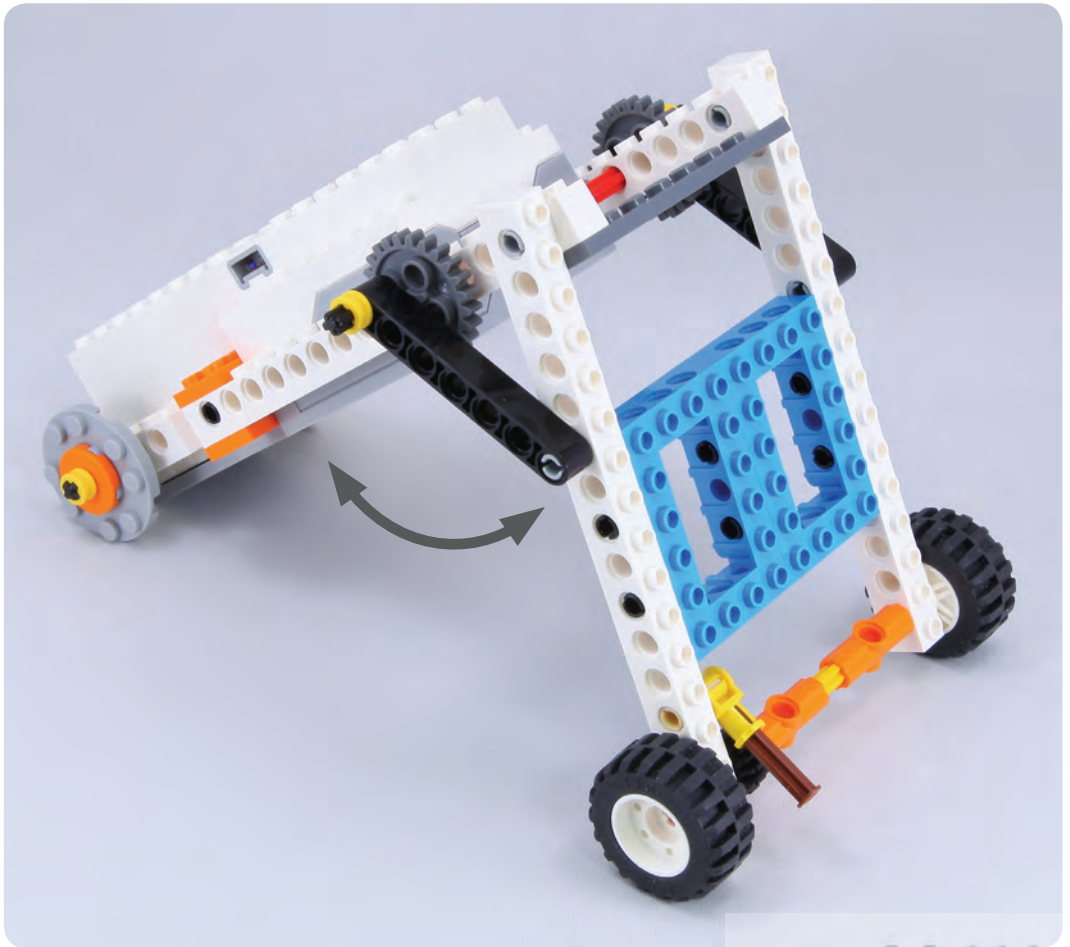
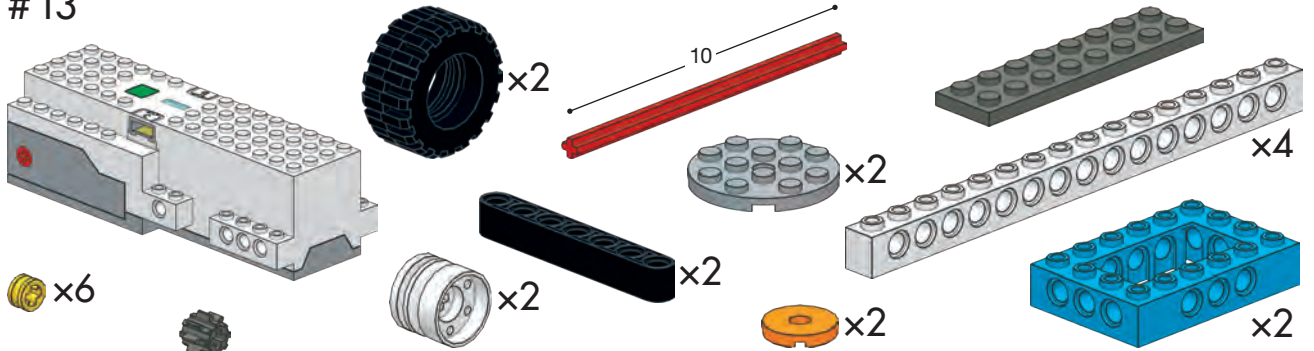



# 會旋轉的東西

# 19

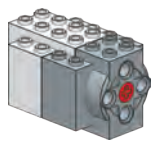
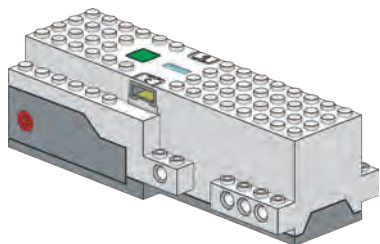

互動式馬達

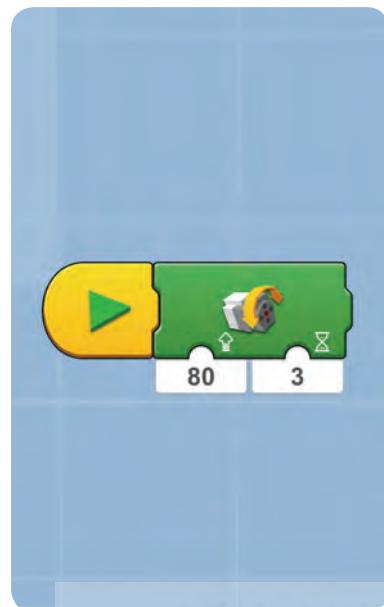
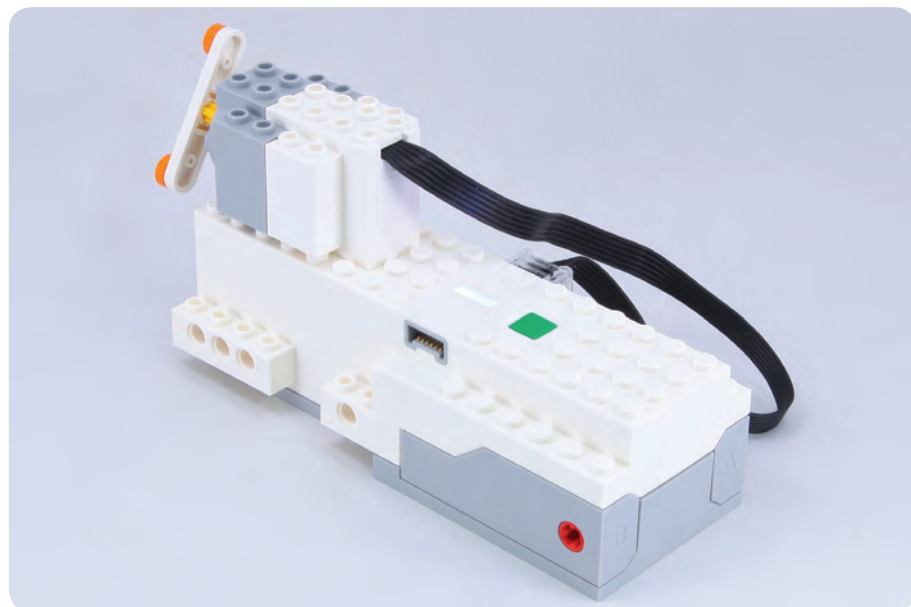
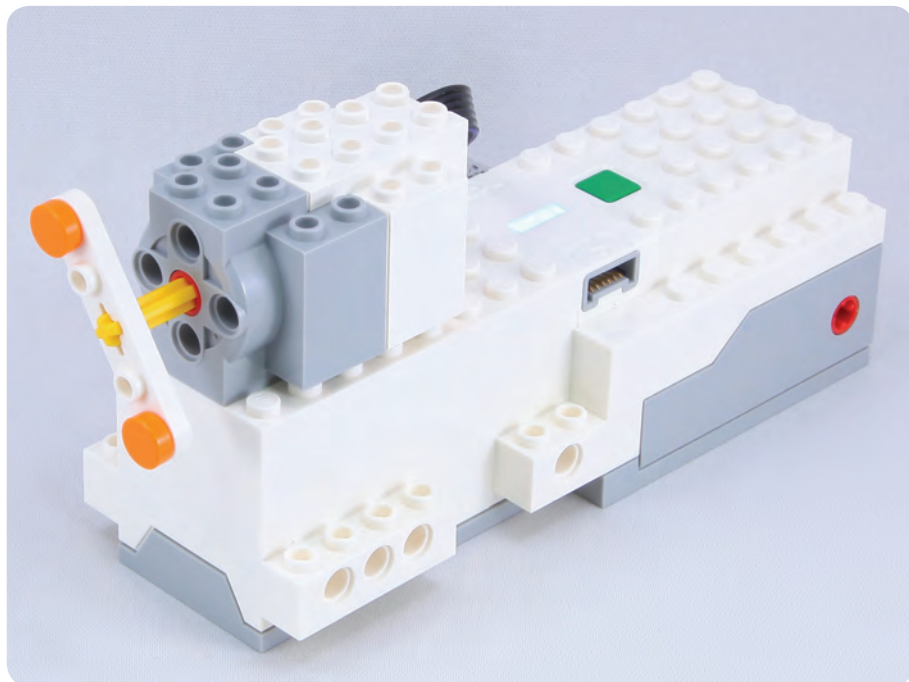
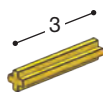

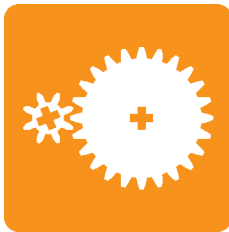

# 使用齒輪來改變速度

#21

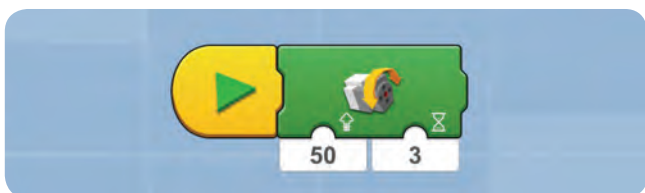
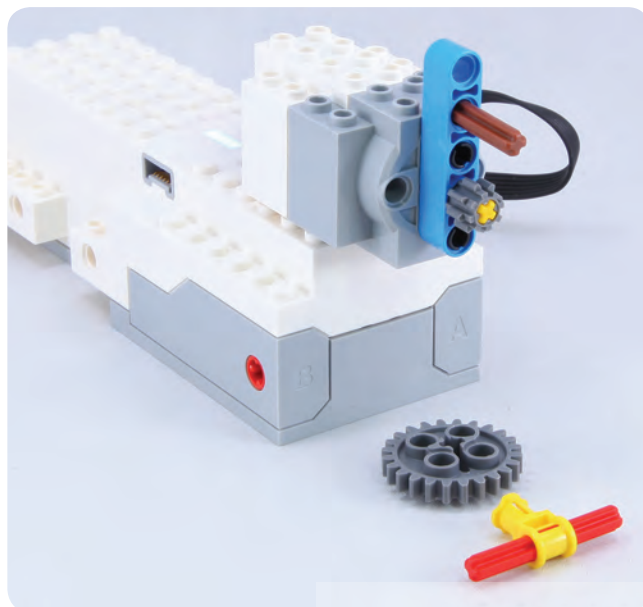
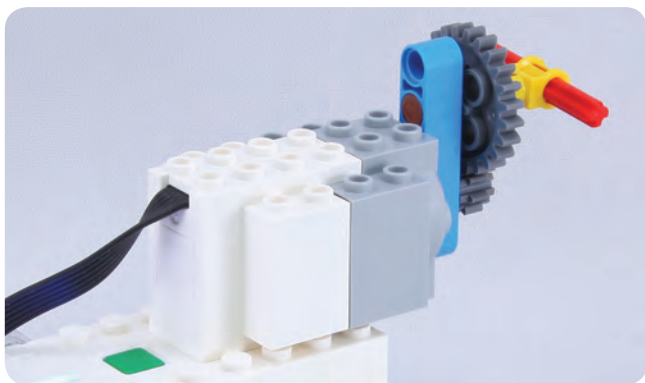
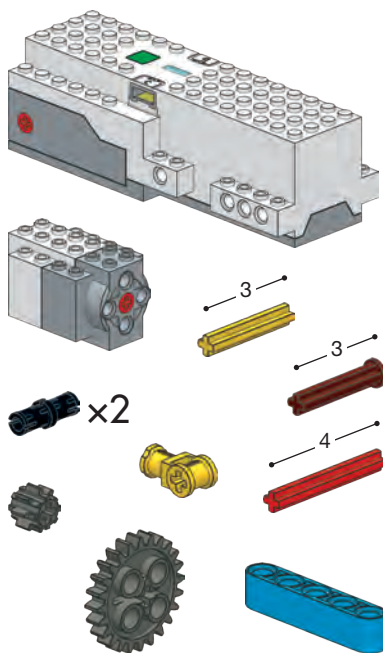



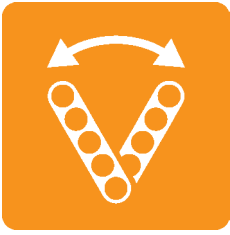

# 搖擺式機構

# 32

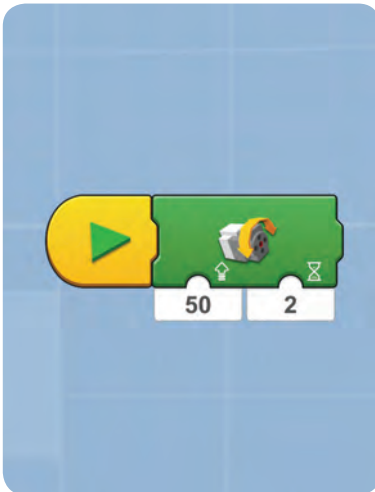
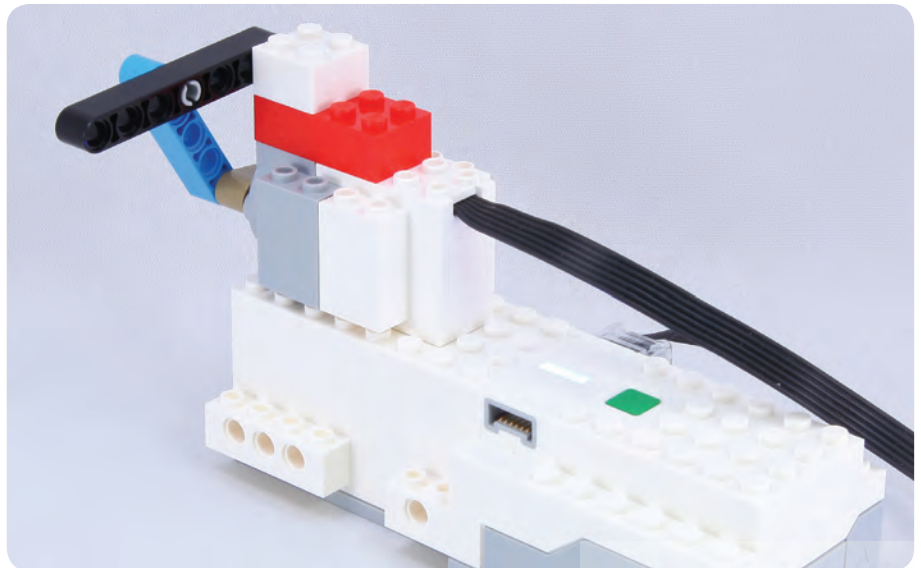
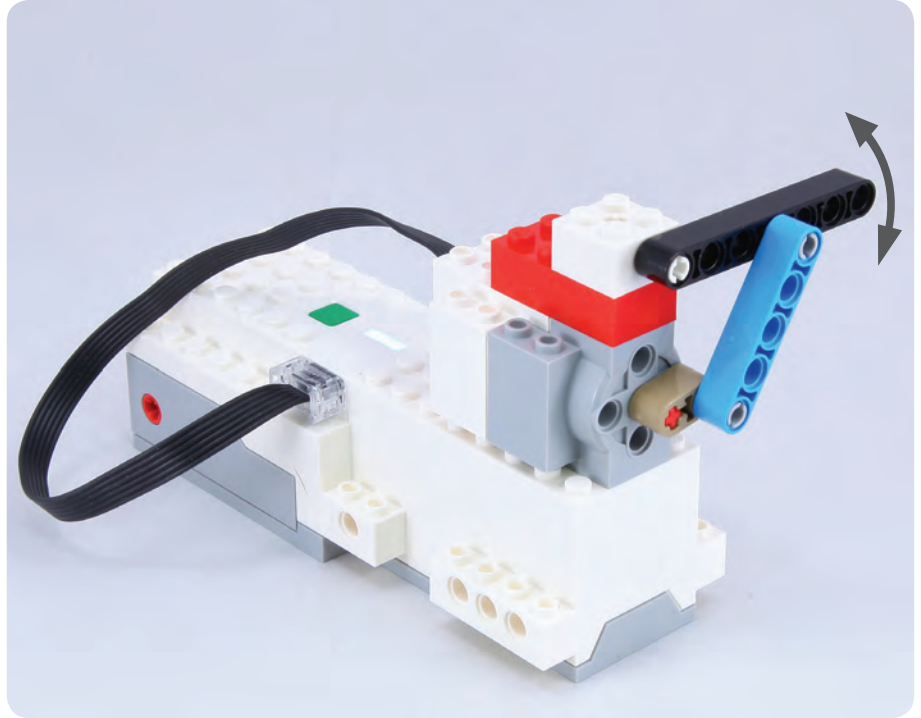
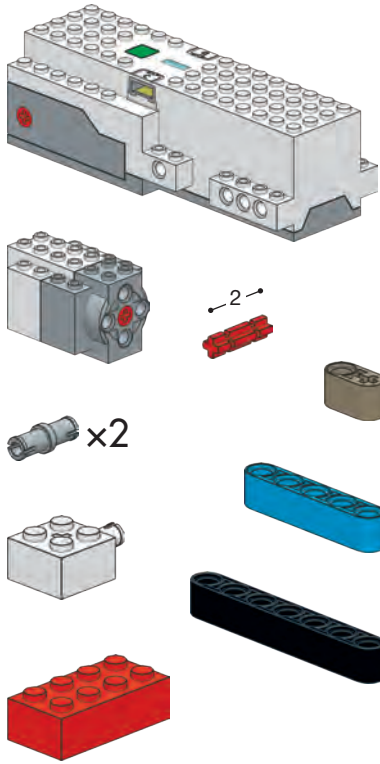

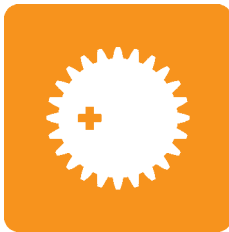

# 轉動用的離心軸

#43

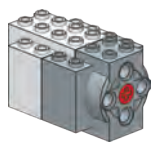
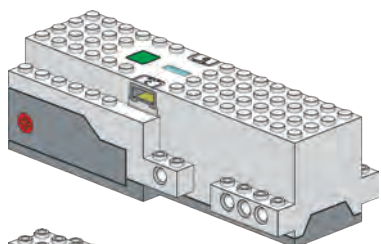

x3

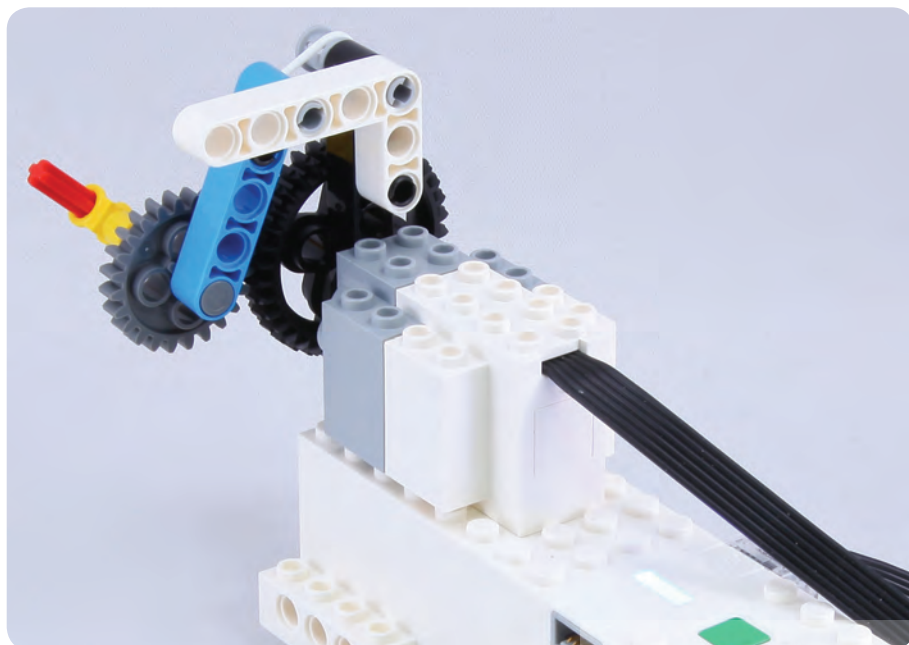
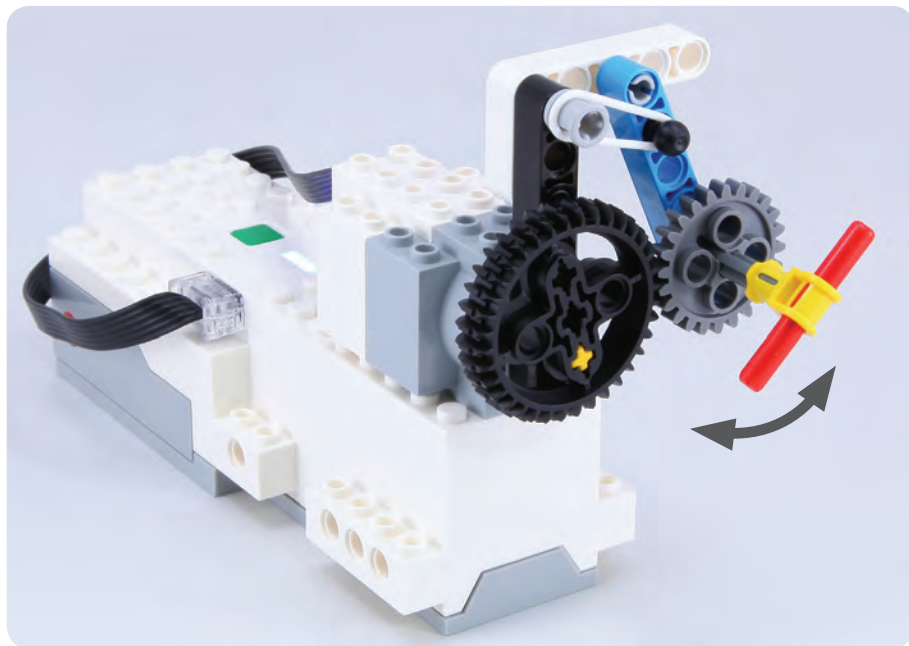
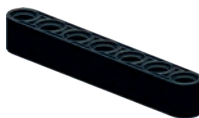
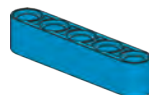
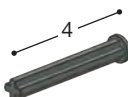
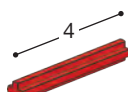
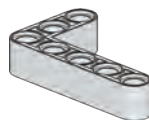

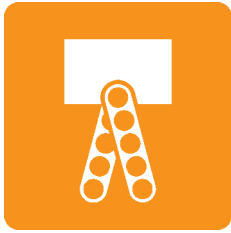

# 使用互動式馬達來走路

#55

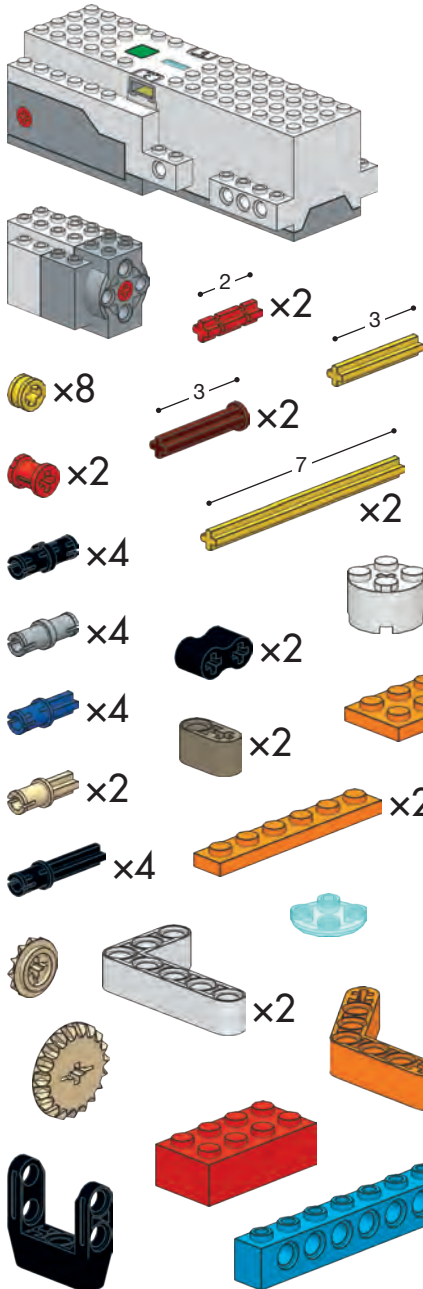

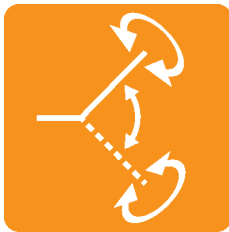

# 任意改變轉動角度

# 61

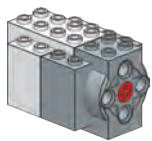
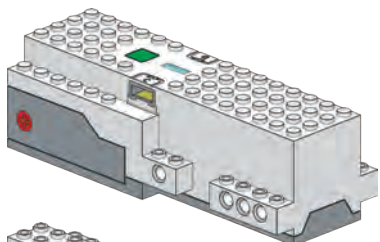

x2



x6



x2

x2

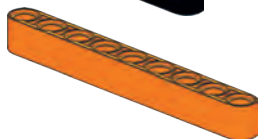

3

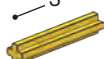

5

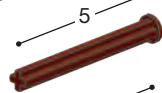

7

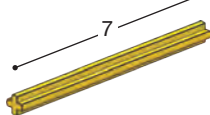

x2

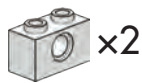

x2

